

# QUASAR

H O L L A N D



## **Cloud**

NL Installatie handleiding

DE Installationsanleitung

EN Installation manual

# 1 NL Informatie / DE Information/ EN Information

## Veiligheidsinformatie



- Onderbreek altijd de stroomtoevoer door verwijderen van de toestelzijdige stop bij de montage, onderhoudswerk en het verwisselen van de gloeilampen.

- Een brandende lamp is heet. Let op brandgevaar.

- De lamp mag niet op geleidend materiaal worden gemonteerd.

- Draag geen sieraden bij onderhoudswerkzaamheden.

- Geen (decoratie) materialen aan het armatuur bevestigen.

## Technische informatie



- Ingangsspanning 120V of 240V

- Uitgangsspanning 12V

- Beschermingsklasse I

- Beschermingsgraad IP20

- De lamp mag niet in openlucht gebruikt worden

- LED: 12V, 0.6W, 2700K, CRI >90

- Ten minste een afstand van 0,5m tenopzichte van het bestraalde oppervlakte houden.

- Technische gelijkvormigheid volgens EN-Richtlijnen

## Sicherheitshinweise

- Bei Montage, Wartungsarbeiten und Leuchtmittelwechsel immer Stromzufuhr durch Entfernen der bauseitigen Sicherung unterbrechen.

Wenn die Leuchte in Betrieb ist, besteht beim Glühmittel Verbrennungsgefahr!

- Leuchte darf nicht auf leitende Materialien montiert werden.

- Kein Juwelen während wartung tragen.

- Kein (dekorations) Materialien an die Leuchte befestigen.

## Technische Hinweise

- Eingangsspannung 120V oder 240V

- Ausgangsspannung 12V

- Schutzklasse I

- Schutzart IP20

- Leuchte darf nicht im Freien verwendet werden.

- LED: 12V, 0.6W, 2700K, CRI >90

- Mindestabstand zur angestrahlten Fläche 0,5m

- Technische Konformität gemäss EU-Richtlinien

## Safety information

- During installation, maintenance work and change of illuminants always interrupt the power supply by removing the respective circuit breaker.

- When switched on, the lamp may cause burns when touched.

- Lamp may not be mounted on conductive materials.

- Don't wear jewelry during maintenance.

- Don't use decoration materials in the lamp.

## Technical data

- Input voltage 120V or 240V

- Output voltage 12V

- Safety class I

- Degree of protection IP20

- Lamp must not be used in the open.

- LED: 12V, 0.6W, 2700K, CRI >90

- Minimum distance from illuminated surface 0.5m

- Technical conformity according to European EN-Regulations

## Onderhoudsinformatie



- De lampen reinigen met in de handel verkrijgbare, niet-agressieve en niet-schurende reinigingsmiddelen

- Gebruik een plumeau

## Pflegehinweise

- Leuchten nur mit handelsüblichen, nicht aggressiven und scheuernden Reinigungsmitteln reinigen.

- Gebrauch eine Federbesen

## Maintenance information

- Lights should only be cleaned using commercially available, non-aggressive, non-scouring cleaning agents.

- Use a feather duster

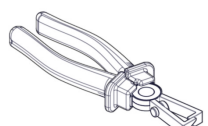
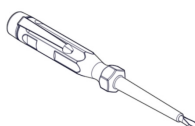
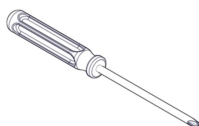
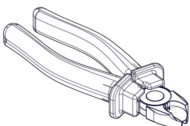
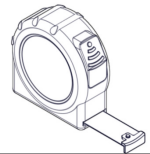
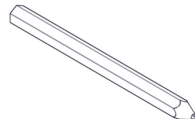
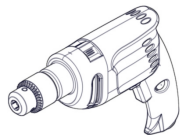
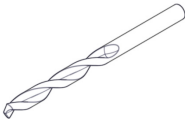

## 2 NL Optioneel dimmer instructies

---

### Dimmen

Indien besteld met optionele dimmer dan is deze klaar voor gebruik.

Met de afstandsbediening kunt u de lamp aan en uit schakelen.

Het dimmen kan in 6 voorgeprogrammeerde stappen

Met de \* knoppen kan de lamp ingesteld worden op de gewenste lichtsterkte.

### Synchroniseren afstandsbediening en dimmodule

1. Zorg er altijd voor dat de stroom bij installatie van de dimmer uit staat!
2. Sluit de dimmodule aan volgens installatieschema.
3. Na het bedraden de stroom inschakelen. Druk op de inleerknop op de dimmodule, druk direct op een van de knoppen van de afstandsbediening, de lamp knippert nu twee keer en is gebruiksklaar.

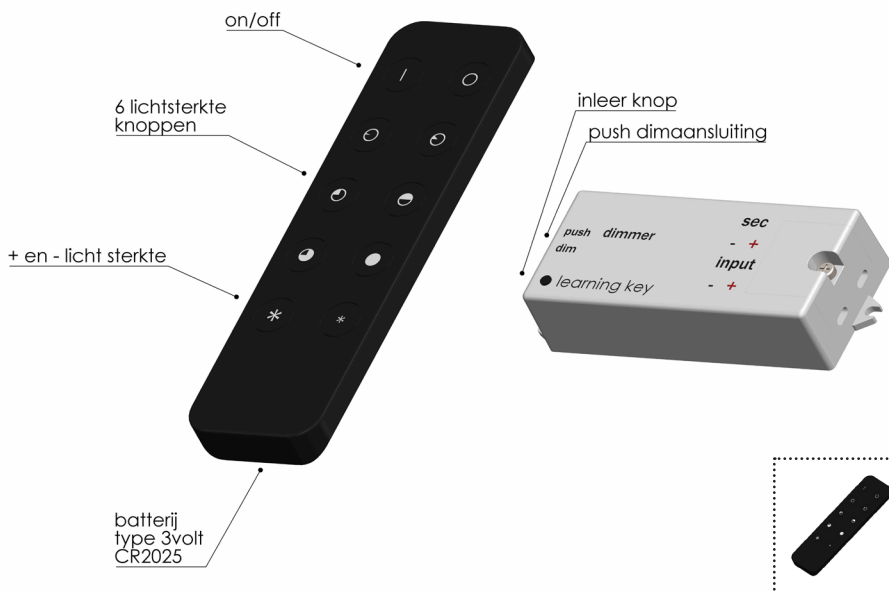

### 3 EN Optional dimming instruction

---

## Dimming

If ordered with the optional dimmer, the dimmer is ready to use and programmed.

The fixture can be switched on and off with the remotecontrol.

Dimmable in 6 different presets.

With the \* button it can be dimmed to the requested brightness.

## Synchronising remotecontrol and dimmodule

1. Switch off the power
2. Connect the dimmodule according to wiringdiagram.
3. Switch on power. Push the programmingbutton , push immediately on one of the buttons of the remotecontrol. The fixture blinks 2 times and is ready for use.

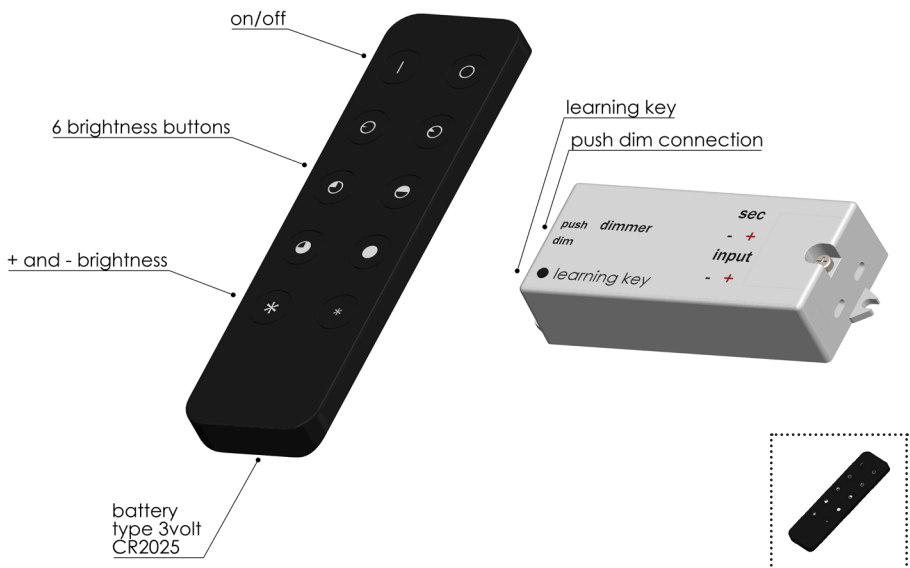

### Dimmen

Falls mit Option Dimmer bestellt wird, ist der Dimmer fertig und programmiert.

Die Leuchte kann an- und ausgeschaltet werden mit den Fernbedienung.

Dimmbar in 6 voreingestellte Stufen.

Mit \* Taste kann man die Leuchten stufenlos dimmen.

### Synchronisieren vom Fernbedienung und Dimmodul

1. Strom ausschalten
2. Dimmodul anschliessen laut verdrahtungsdiagram.
3. Strom anschalten. Programmtaste eindrücken. Gleich einer Taste vom Fernbedienung drücken. Die Leuchte blinkt 2 Mal und ist fertig.

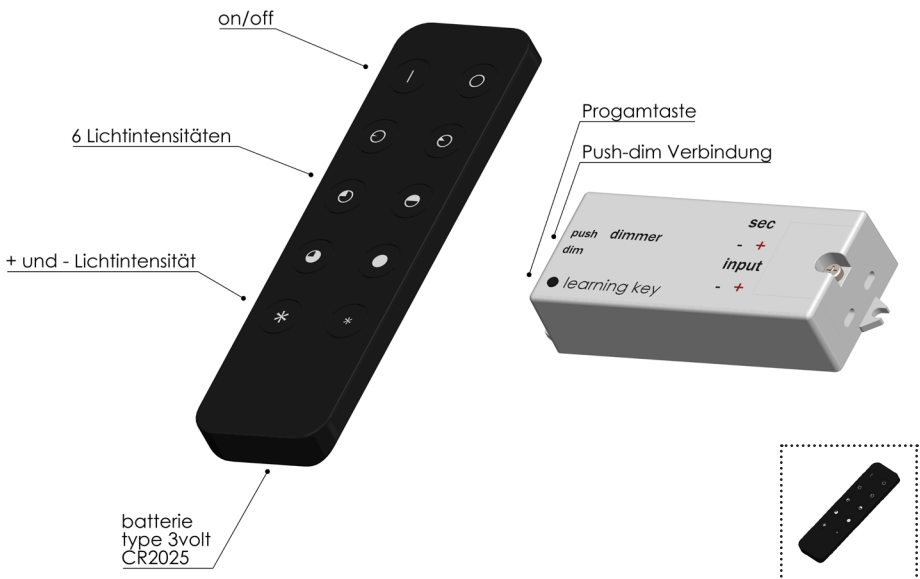

## 5.1 NL Installatie / EN Installation / DE Installation

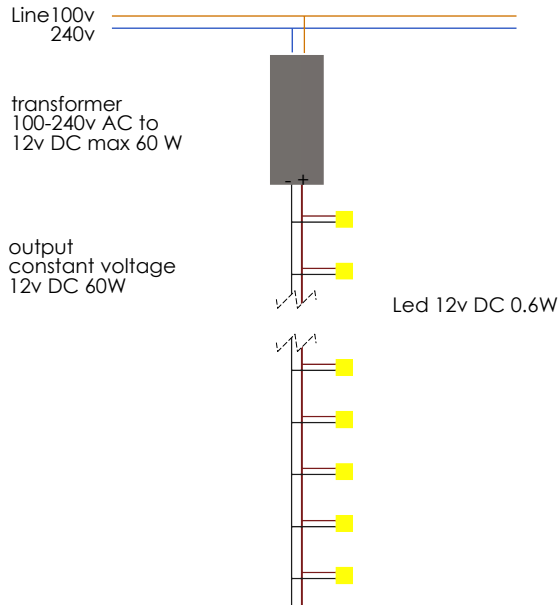

## 5.2

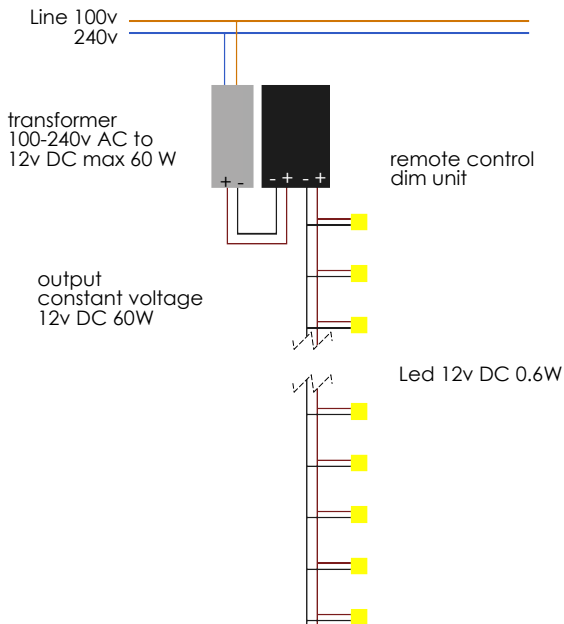

### 5.3 NL Installatie / EN Installation / DE Installation

---

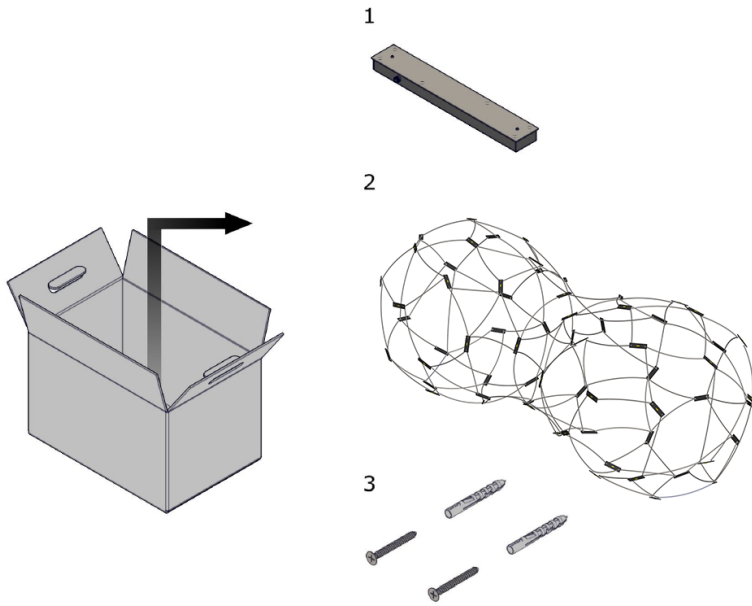

### 5.4

---

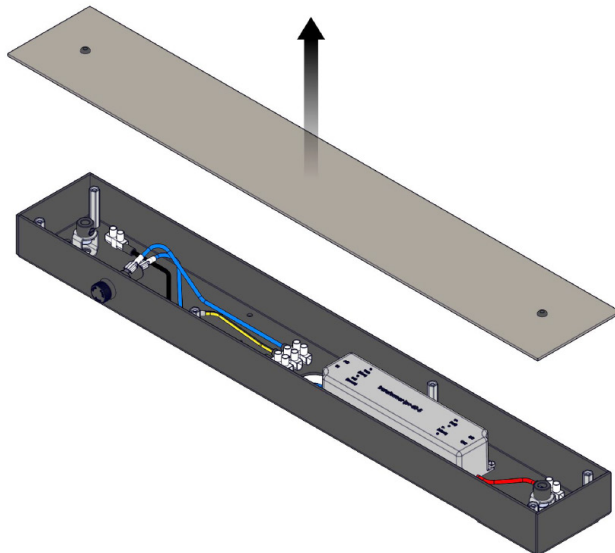



## 5.5 NL Installatie / EN Installation / DE Installation

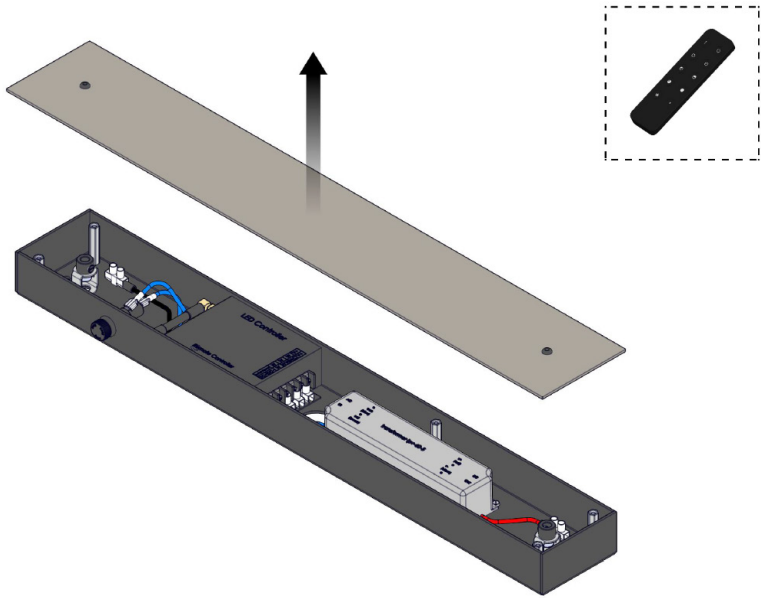

## 5.6

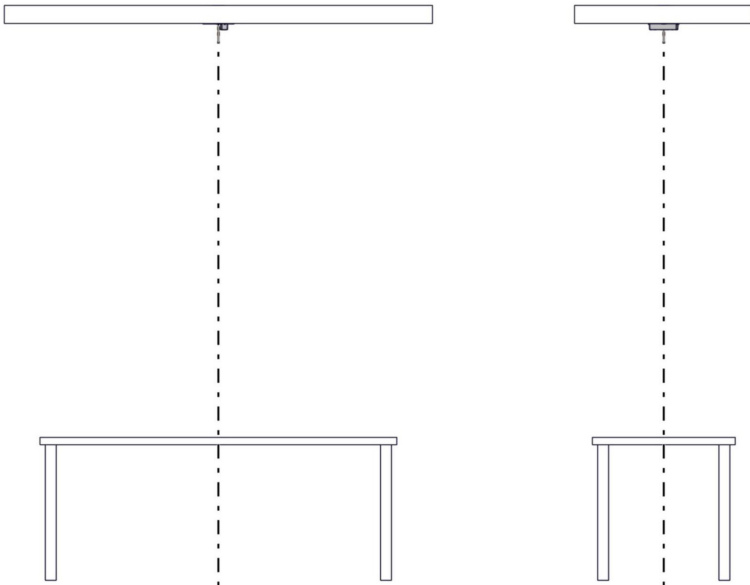



## 5.7 NL Installatie / EN Installation / DE Installation

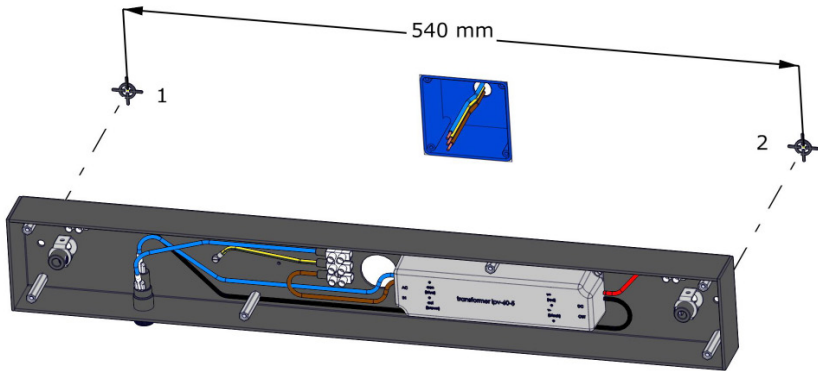
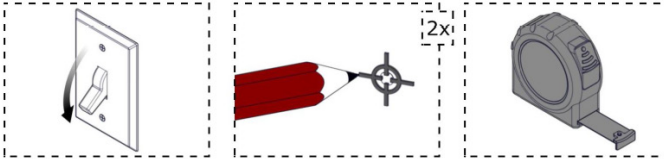

## 5.8

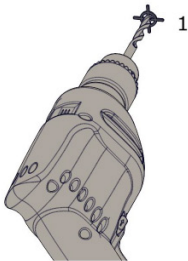
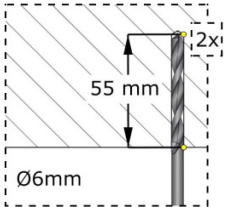

## 5.9 NL Installatie / EN Installation / DE Installation

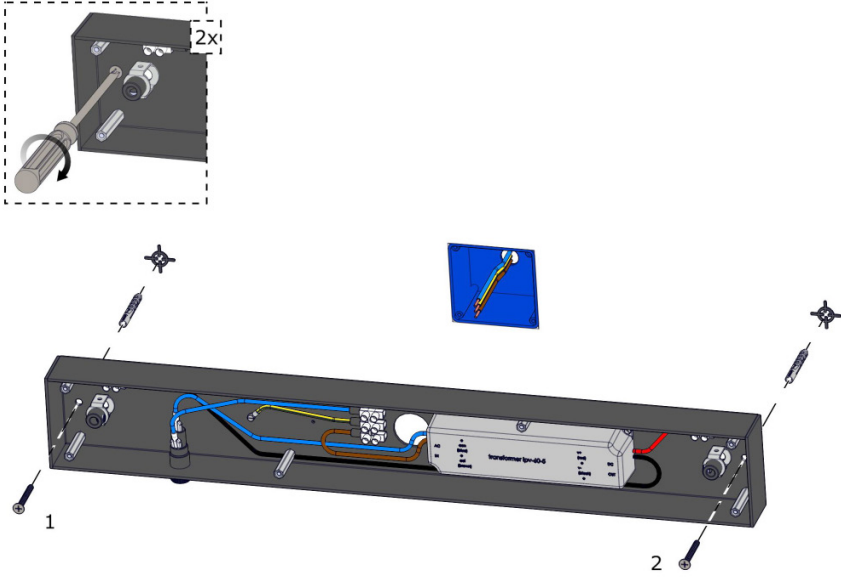

## 5.10

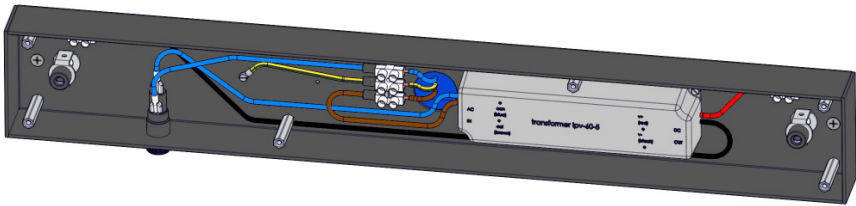

100V / 240V

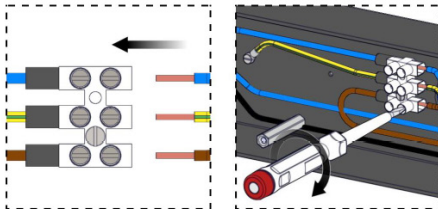

5.11 NL Installatie / EN Installation / DE Installation

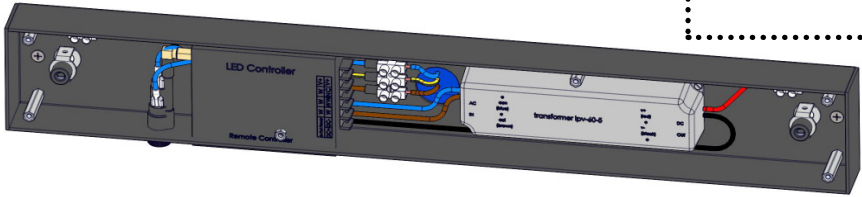
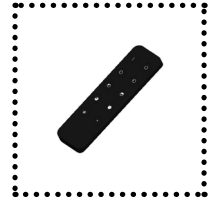

100V / 240V

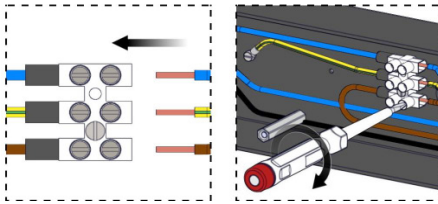

5.12

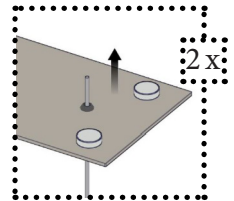
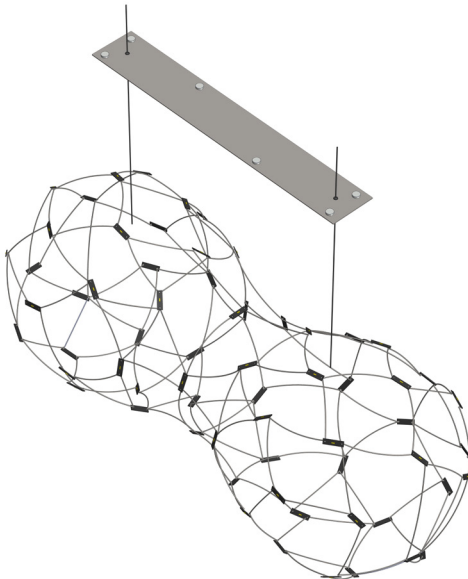

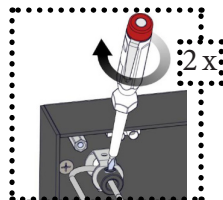
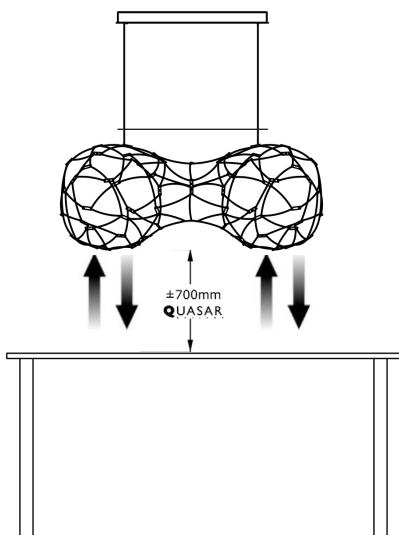
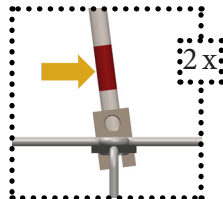
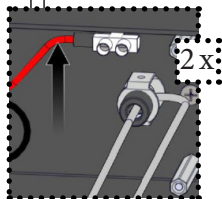
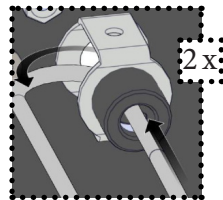
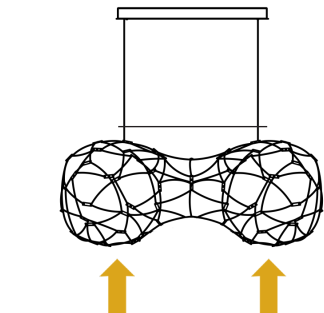

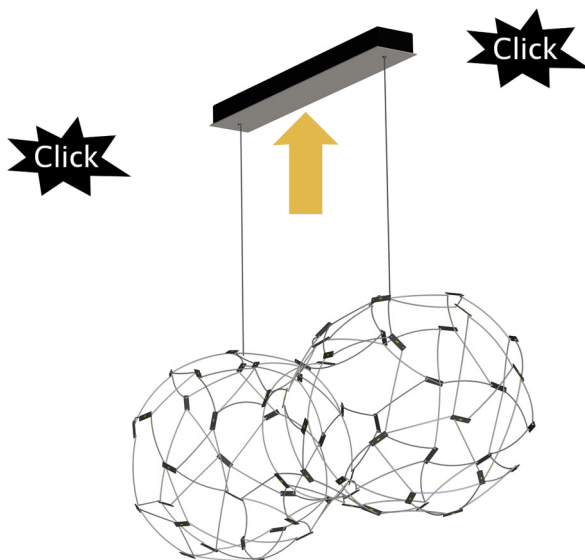

5.16

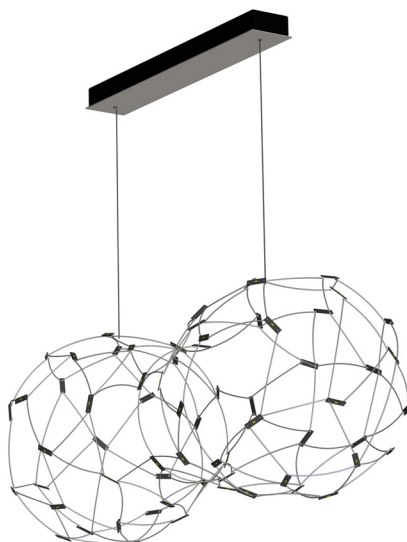
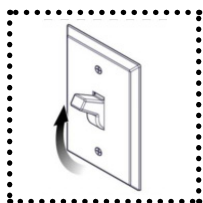

Zie zekerung voor type  
See fuse for type  
siehe zum Sicherungstyp







Quasar Holland B.V.  
Burgstraat 2  
4283 GG GIESSEN  
THE NETHERLANDS

T. 31-183-447887  
E. [info@quasar.nl](mailto:info@quasar.nl)  
I. [www.quasar.nl](http://www.quasar.nl)

Date: 17-07-2017  
Version: 1